

Additional Installation, Operation and  
Maintenance Instructions



# ecocirc S, M, L ecocirc S+, M+, L+ Wet Rotor Circulators

# Table of Contents

1	Introduction and Safety.....	5
1.1	Introduction .....	5
1.2	Safety .....	5
1.2.1	Danger levels and safety symbols.....	5
1.2.2	User safety .....	6
1.2.3	Protection of the environment .....	7
1.2.4	Sites exposed to ionizing radiations .....	7
2	Handling and Storage .....	8
2.1	Handling of the packed unit .....	8
2.2	Unit inspection upon delivery .....	8
2.2.1	Inspect the package.....	8
2.2.2	Unpacking and inspection of the unit .....	8
2.3	Storage .....	8
3	Technical Description.....	9
3.1	Designation .....	9
3.2	Features and integrated functions.....	9
3.3	Data plate .....	9
3.4	Identification code.....	10
3.5	Names of the main components.....	10
3.5.1	Drive display .....	10
3.6	Intended use.....	11
3.7	Improper use .....	11
3.8	Use in water distribution networks for human consumption.....	12
4	Installation.....	13
4.1	Precautions .....	13
4.2	Installation area.....	13
4.3	Hydraulic connection .....	13
4.3.1	Guidelines for hydraulic connection .....	14
4.3.2	Assembly .....	14
4.3.3	Rotation of the drive display .....	15
4.3.4	Insulation .....	16
4.4	Electrical connection.....	17
4.4.1	Ground.....	17
4.4.2	Guidelines for electrical connection.....	17
4.4.3	Mounting the connector .....	17
5	Start-up .....	19
5.1	Precautions .....	19

---

5.2	Before start-up .....	19
5.3	Initial start-up .....	19
5.4	Venting the unit .....	20
6	Settings and operation .....	21
6.1	Knob settings .....	21
6.1.1	Stand-by .....	21
6.1.2	Operation with constant pressure .....	22
6.1.3	Operation with proportional pressure .....	22
6.1.4	Operation with constant pump speed .....	22
6.1.5	eAdapt function, ecocirc+ .....	23
6.1.6	Degassing function .....	23
6.2	Night mode, ecocirc+ .....	23
6.3	MY ecocirc App, ecocirc+ .....	24
6.3.1	Pairing the unit with a mobile device .....	24
6.4	Starting at high torque .....	25
6.5	Dry run signal .....	25
7	Maintenance .....	26
7.1	Precautions .....	26
7.2	Spare parts ordering .....	26
8	Troubleshooting .....	27
8.1	Precautions .....	27
8.1.1	Resetting errors .....	27
8.2	Insufficient cooling or heat .....	27
8.3	Unit not functioning and LED on .....	28
8.4	Unit not functioning and LED off .....	28
8.5	Loss of functionality in the unit .....	29
8.6	The wireless connection is not functioning, ecocirc+ .....	29
8.7	Noise coming from the system .....	29
8.8	Noise coming from the unit .....	30
9	Technical Information .....	31
9.1	Operating environment .....	31
9.2	Pumped liquid .....	31
9.3	Mechanical characteristics .....	31
9.4	Electrical specifications .....	32
9.5	Radiofrequency specifications, ecocirc+ .....	32
9.6	Maximum head .....	32
9.7	Maximum operating pressure .....	32
9.8	Energy efficiency .....	32
9.9	Sound pressure .....	32
9.10	Materials in contact with the liquid .....	33
9.11	Dimensions and weights .....	33
10	Disposal .....	34

10.1	Precautions .....	34
10.2	WEEE 2012/19/EU (50 Hz) .....	34
11	Declarations.....	35
11.1	EC Declaration of Conformity (Original).....	35
11.2	EU Declaration of Conformity (n. 39).....	35
12	Warranty.....	37
12.1	Information .....	37

# 1 Introduction and Safety

## 1.1 Introduction

### Purpose of this manual

This manual provides information on how to do the following in the correct manner:

- Installation
- Operation
- Maintenance.



### CAUTION:

This manual is an integral part of the unit. Be sure to read and understand the manual before installing the unit and putting it to use. The manual must always be made available to the user, stored in the proximity of the unit, and well kept.

### Supplementary instructions

The instructions and warnings of this manual apply to the standard unit as described in the sale documentation. Special version pumps may be supplied with supplementary instruction manuals. For situations not considered in the manual or in the sales document, contact Xylem or the Authorised Distributor.



## 1.2 Safety

### 1.2.1 Danger levels and safety symbols







Before using the unit, the user must read, understand and comply with the indications of the danger warnings in order to avoid the following risks:

- Injuries and health hazards
- Damage to the product
- Unit malfunction.

### Danger levels

Hazard level	Indication
 <b>DANGER:</b>	It identifies a dangerous situation which, if not avoided, causes serious injury, or even death.
 <b>WARNING:</b>	It identifies a dangerous situation which, if not avoided, may cause serious injury, or even death.
 <b>CAUTION:</b>	It identifies a dangerous situation which, if not avoided, may cause small or medium level injuries.
<b>NOTICE:</b>	It identifies a situation which, if not avoided, may cause damage to property but not to people.

Complementary symbols

Symbol	Description
	Electrical hazard
	Hot surface hazard
	Danger, system pressurized
	Do not use flammable liquids
	Do not use corrosive liquids
	Read the instruction manual

1.2.2 User safety

Strictly comply with current health and safety regulations.



**WARNING:**

This unit must be used only by qualified users. Qualified users are people able to recognise the risks and avoid hazards during installation, use and maintenance of the unit.

Inexperienced users



**WARNING:**

- For EU countries: this product may be used by children aged 8 years and above and persons with reduced physical, sensory or mental capabilities, or who lack experience and knowledge, provided that they are being supervised and have been instructed on how to use it safely, and understand the hazards involved. Children must not play with the product. Cleaning and maintenance must not be carried out by children without supervision.
- For countries outside the EU: this product is not intended for use by persons (including children) with reduced physical, sensory or mental capabilities, or who lack experience and knowledge, unless they are being supervised and have been instructed on how to use it by a person responsible for their safety. Children should be supervised to ensure that they do not play with the product.

### 1.2.3 Protection of the environment

#### Disposal of packaging and product

Comply with the current regulations on sorted waste disposal.

### 1.2.4 Sites exposed to ionizing radiations



---

**WARNING: Ionizing radiation hazard**

If the unit has been exposed to ionizing radiations, implement the necessary safety measures for the protection of people. If the unit needs to be dispatched, inform the carrier and the recipient accordingly, so that appropriate safety measures can be put in place.

---

# 2 Handling and Storage

## 2.1 Handling of the packed unit



---

**WARNING:**

Take appropriate measures during transport, installation and storage to prevent contamination from external substances.

---

The Manufacturer delivers the unit and its components in a cardboard box.

## 2.2 Unit inspection upon delivery

### 2.2.1 Inspect the package

1. Check that quantity, descriptions and product codes match the order.
2. Check the packaging for any damage or missing components.
3. In case of immediately detectable damage or missing parts:
  - accept the goods with reserve, indicating any findings on the transport document, or
  - reject the goods, indicating the reason on the transport document.

In both cases, promptly contact Xylem or the Authorised Distributor from whom the product was purchased.

### 2.2.2 Unpacking and inspection of the unit

1. Remove packing materials from the product.
2. Check the unit for integrity and to make sure that there are no missing components.
3. In case of damage or missing components, promptly contact Xylem or the Authorised Distributor.

#### Content of the package

- Unit
- Heat insulation shell
- Two gaskets
- Supply connector
- Instructions manual.

## 2.3 Storage

### Storage of the packed unit

The unit must be stored:

- In a covered and dry place
- Away from heat sources
- Protected from dirt
- Protected from vibrations
- At an ambient temperature between -40°C and +85°C (-40°F and 185°F).

---

**NOTICE:**

Do not place heavy loads on top of the unit.

---

**NOTICE:**

Protect the unit from collisions.

---



# 3 Technical Description

## 3.1 Designation

Wet rotor circulators with integrated electronic frequency converter.

## 3.2 Features and integrated functions

Reading and adjustment

Feature / function	ecocirc	ecocirc+
Knob	•	•
Indication of faults	•	• with fault
Display		•

Control and operating mode

Feature / function	ecocirc	ecocirc+
Operation at constant pressure	•	•
Operation at proportional pressure	•	•
Operation at constant speed	•	•
Degassing	•	•
eAdapt		•
Night mode		•
Bluetooth® wireless function		•

## 3.3 Data plate

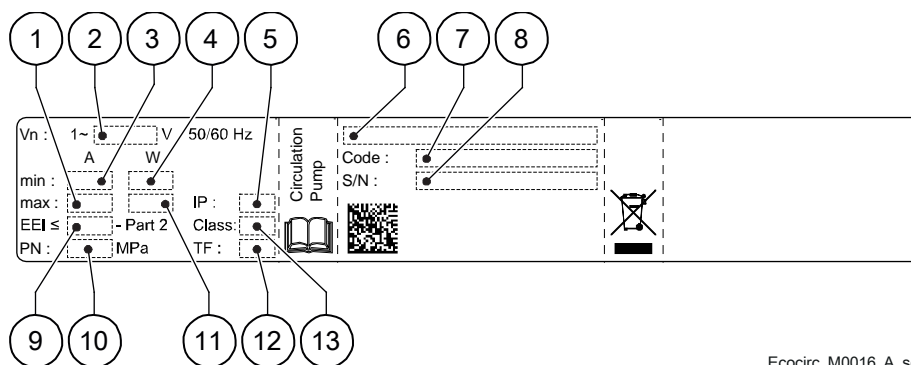

Ecocirc\_M0016\_A\_sc

### 3.4 Identification code

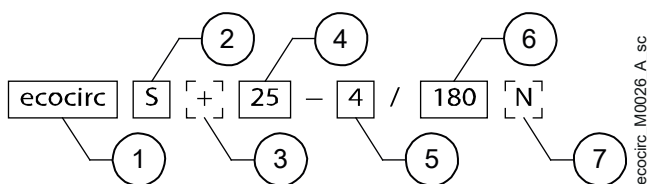

1. Series name
2. Motor power 24 W [S], 34 W [M] or 60 W [L]
3. Display present [+] or not present [ ]
4. Port nominal diameter in mm
5. Maximum head in mm
6. Distance between suction port and discharge port in mm
7. Pump body in cast iron [ ] or stainless steel [N]

### 3.5 Names of the main components



1. Pump body
2. Discharge of condensate
3. Motor body
4. Electronic drive
5. Drive display
6. Control knob
7. Socket for the power connector

#### 3.5.1 Drive display

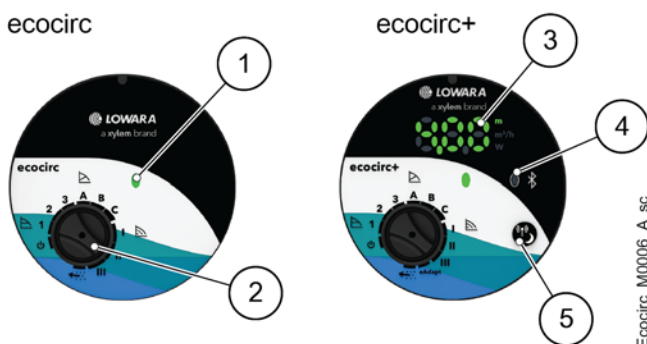

1. Unit status LED indicator
2. Work and operating mode knob
3. Display
4. Bluetooth® wireless function LED indicator
5. Button to enable and disable night mode and the Bluetooth® wireless function

## Display, ecocirc+

The information given on the display according to the event is shown in the table:

Event	Information on the display
Unit in standby	OFF
Unit in operation	Every 4 seconds, in a cycle: <ul style="list-style-type: none"> <li>• head in meters</li> <li>• instantaneous flow rate in cubic meters per second</li> <li>• instantaneous power in watts</li> </ul>
Degassing function active	Alr
eAdapt function activated	EAd
Presence of a fault	Alphanumeric error code, see Troubleshooting on page 27

### 3.6 Intended use

- Gas, diesel oil, wood and pellet boiler
- District heating systems
- Underfloor heating systems
- Multi-zone heating systems
- Cogeneration processes
- Heat transfer stations
- Mixing stations
- Heat pumps
- Domestic hot water systems
- Air-conditioning systems.

#### Pumped liquids

- Clean
- Free of solid particles or fibres
- Free of mineral oils
- Chemically and mechanically non aggressive
- Non-flammable
- Non-explosive
- Water/glycol mixtures
- Water for heating according to VDI 2035
- Domestic hot water

Observe the operating limits in **Technical Information** on page 31.

### 3.7 Improper use



---

**WARNING:**

The unit was designed and built for the use described in the **Intended Use** section. Any other uses are prohibited, as they could compromise the safety of the user and the efficiency of the unit itself.

---



---

**DANGER:**

It is prohibited to use this unit to pump flammable and/or explosive liquids.

---



---

**DANGER: Potentially explosive atmosphere hazard**

It is prohibited to start the unit in environments with potentially explosive atmospheres or with combustible dusts.

---



---

**DANGER:**

In the case of domestic systems, the water must be pumped at a temperature above +50°C (122°F) to prevent the risk of legionella.

---



---

**DANGER:**

In the case of domestic hot water systems, flexible pipes must not be used to connect the unit to the mains water supply.

---



---

**CAUTION:**

It is prohibited to use this unit to pump aggressive liquids, acids and seawater.

---

### 3.8 Use in water distribution networks for human consumption

If the unit is intended for water supply to people and/or animals:

---



---

**WARNING:**

It is prohibited to pump drinking water after use with other fluids.

---



---

**WARNING:**

Take appropriate measures during transport, installation and storage to prevent contamination from external substances.

---



---

**WARNING:**

Remove the unit from its packaging just before installation to prevent contamination from external substances.

---



---

**WARNING:**

After installation, run the unit for a few minutes with several users open in order to wash the inside of the system.

---

# 4 Installation

## 4.1 Precautions

Before starting, make sure that the safety instructions shown in **Introduction and Safety** on page 5 have been fully read and understood.



**DANGER: Potentially explosive atmosphere hazard**

It is prohibited to start the unit in environments with potentially explosive atmospheres or with combustible dusts.



**WARNING:**

Always wear personal protective equipment.



**WARNING:**

Always use suitable working tools.



**WARNING:**

When selecting the place of installation and connecting the unit to the hydraulic and electric power supplies, strictly comply with current regulations.

When connecting the unit to a public or private aqueduct, or to a well for the supply of water for human and/or animal consumption:



**WARNING:**

It is prohibited to pump drinking water after use with other fluids.



**WARNING:**

Remove the unit from its packaging just before installation to prevent contamination from external substances.

## 4.2 Installation area

- Install the unit in a dry and well ventilated area, protected against weather conditions.
- Follow the provisions in Operating environment on page 31.

## 4.3 Hydraulic connection



**DANGER:**

All the hydraulic and electrical connections must be completed by a technician possessing the technical-professional requirements outlined in the current regulations.



**WARNING:**

Piping must be sized to ensure safety at the maximum operating pressure.



**WARNING:**

Install appropriate seals between the unit and the piping system.

**4.3.1 Guidelines for hydraulic connection**

- If possible, install the unit at the lowest point of the system
- Remove any welding residues, deposits and impurities in the pipes that could damage the unit.
- To exclude the unit from the system for the purpose of maintenance, install an on-off valve on the suction side and another on the delivery side
- Support the pipes independently to prevent them from weighing on the unit.
- Check that other devices cannot come in contact with the unit.

**4.3.2 Assembly**



**CAUTION: Danger, system pressurized**

Before starting work, close the on-off valves on the suction and delivery sides or drain the system.

1. Locate the arrow on the unit to determine the correct direction of the flow of liquid.
2. Insert the unit between the pipes with the gaskets.
3. Tighten the nuts in the joints.  
Tightening torque: see the table.

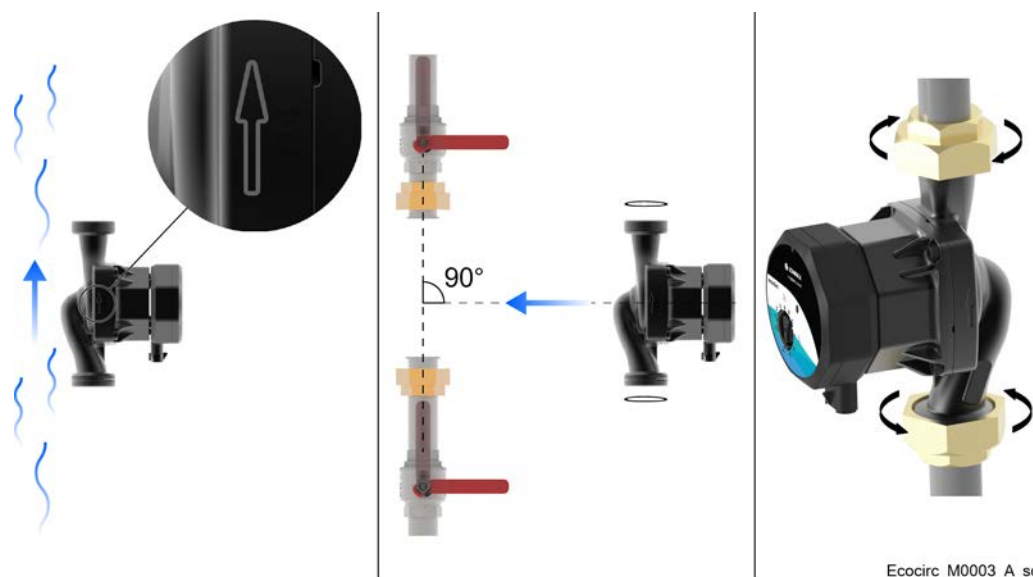

Size of the joint	Material of the pipe	Torque, Nm (lbf-ft)
G1	Plastic	50 (37)
G1	Cast iron	85 (63)
G1¼	Cast iron	105 (78)
G1½	Cast iron	125 (92)
G2	Cast iron	165 (122)

## Mounting positions

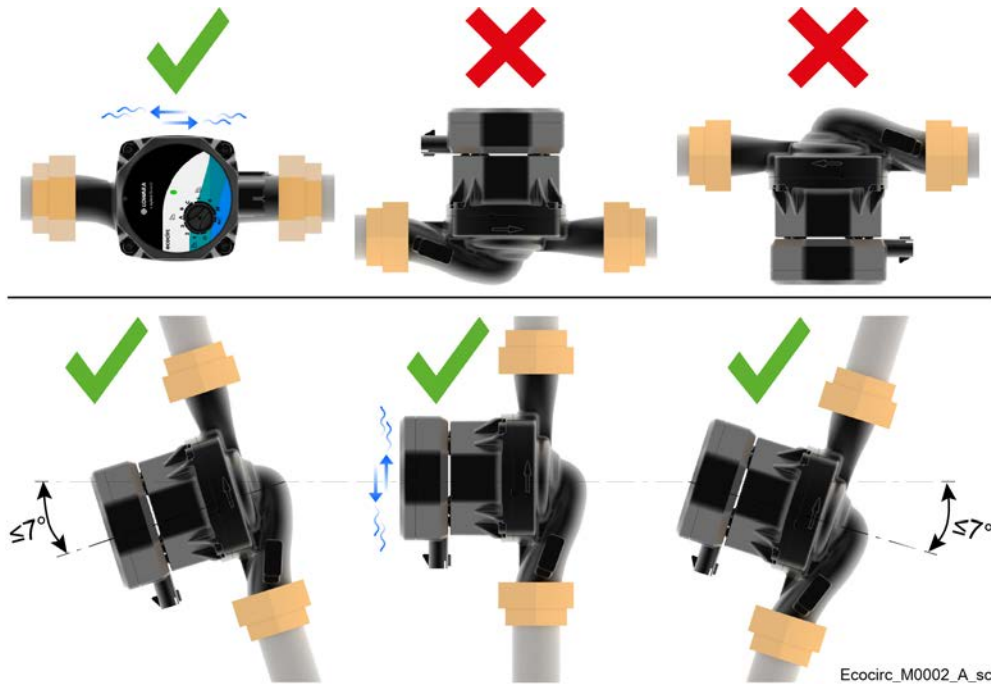

Ecocirc\_M0002\_A\_sc

### 4.3.3 Rotation of the drive display

The drive display can be turned  $90^\circ$  at a time.



**CAUTION: Danger, system pressurized**

Before starting work, close the on-off valves on the suction and delivery sides or drain the system.



**CAUTION:**

Residual liquid could come out of the motor body during disassembly at a very hot or cold temperature: be careful to avoid physical injury.



**CAUTION:**

Make sure not to damage the internal gasket, otherwise liquid could leak out at a very hot or cold temperature during operation of the unit.

**NOTICE:**

During disassembly, support the motor body and not the electronic drive, in order to avoid damaging the electronic drive.

1. Remove the screws.
2. Turn the motor body without detaching it from the body of the pump.
3. Fasten the screws following a cross pattern.  
Tightening torque: 3 Nm (2.2 lbf-ft).



#### Positions of the drive display



#### 4.3.4 Insulation

Install the insulation shells to reduce heat dispersion.

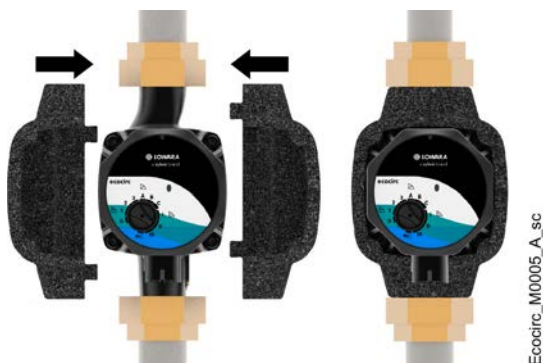

---

#### NOTICE:

Do not insulate or cover the drive display.

---



## 4.4 Electrical connection



**DANGER:**

All the hydraulic and electrical connections must be completed by a technician possessing the technical-professional requirements outlined in the current regulations.



**DANGER: Electrical hazard**

Before starting work, check that the power supply is disconnected and locked out, to avoid unintentional restart of the unit, the electronic drive and the auxiliary control circuit.

### 4.4.1 Ground



**DANGER: Electrical hazard**

Always connect the external protection conductor (ground) to the ground terminal before attempting to make any other electrical connections.



**DANGER: Electrical hazard**

Check that the external protection conductor (ground) is longer than the phase conductors; In case of accidental disconnection of the unit from the phase conductors, the protection conductor must be the last one to detach itself from the terminal.



**DANGER: Electrical hazard**





Install suitable systems for protection against indirect contact, in order to prevent lethal electric shocks.

### 4.4.2 Guidelines for electrical connection

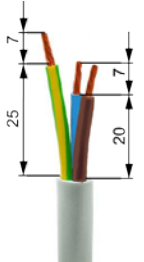
- The mains voltage and frequency must match the specifications on the data plate
- Use a H05V2V2-F 3G0.75-1.5 multi-core power supply cable
- Protect the power supply cable against high temperatures, vibrations, collisions and abrasions.

### 4.4.3 Mounting the connector

Phase	Action	Illustration
1	Insert the cable in the nut, ring and body of the cable gland	 EcoCirc_M0009_A_ph
2	Strip the conductors as shown	 EcoCirc_M0010_A_ph

3	Press the lever of the connector	 <p style="text-align: right; font-size: small;">Ecocirc_M0011_A_ph</p>
4	Insert the cores of the conductors in the respective holes of the connector and release the lever	 <p style="text-align: right; font-size: small;">Ecocirc_M0012_A_ph</p>
5	Engage the connector in the body of the cable gland	 <p style="text-align: right; font-size: small;">Ecocirc_M0013_A_ph</p>
6	Insert the ring in the seat of the body of the cable gland and tighten the nut on the body of the cable gland Tightening torque: 2 Nm (1.5 lbf-ft)	 <p style="text-align: right; font-size: small;">Ecocirc_M0014_A_ph</p>
7	Insert the connector in the socket of the unit	 <p style="text-align: right; font-size: small;">Ecocirc_M0015_A_ph</p>

# 5 Start-up

## 5.1 Precautions



**WARNING: Electrical hazard**

Check that the unit is properly connected to the mains power supply.



**WARNING:**

It is prohibited to put combustible materials near the unit.

**NOTICE:**

Dry run of the unit is forbidden.

**NOTICE:**



It is prohibited to operate the unit with the on-off valve closed.

## 5.2 Before start-up

Check that:

- The instructions in **Installation** on page 5 have been followed.
- The system is full and vented.
- The minimum suction pressure is the same as that indicated in **Technical Information** on page 31.

## 5.3 Initial start-up



Action	LED	ecocirc	ecocirc+
Turn on the power supply	Flashing yellow light		

Note: the unit comes with stand-by set in the factory.

## 5.4 Venting the unit

Vent the unit:

- During filling
- During operation, to remove the dissolved gases (degassing)

Action	LED	ecocirc	ecocirc+
Keep the knob turned to  until the unit is completely vented	Green flashing		

Notes:

- Once activated, degassing continues for 3 minutes irrespective of the set mode
- Depending on the features of the system, it may be necessary to activate degassing for more than 3 minutes.

# 6 Settings and operation

## 6.1 Knob settings

Turn the knob to select the required mode.

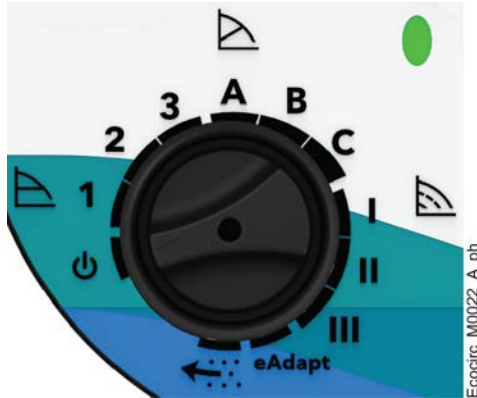

Position of the knob	Description
	Standby
1, 2, 3	Operation with constant pressure
A, B, C	Operation with proportional pressure
I, II, III	Operation with constant pump speed
eAdapt	eAdapt function
	Degassing function

### 6.1.1 Stand-by

Operation of the unit put on hold.

Action	LED	ecocirc	ecocirc+
Turn the knob to	Flashing yellow light		

### 6.1.2 Operation with constant pressure

The pressure remains constant irrespective of the system's actual demand for flow. Suitable for underfloor heating systems and without characteristic curve.

Select the level of head according to the features of the system and/or heat demand.

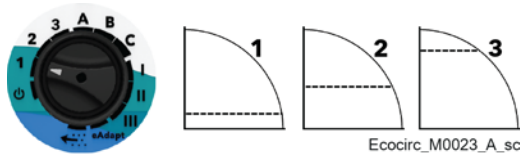

Position	Description
1	Low performance curve
2	Intermediate performance curve
3	High performance curve

### 6.1.3 Operation with proportional pressure

The pressure is constantly adapted according to the system's actual demand for heat. Suited for two-pipe heating systems.

Select the performance according to the features of the system and/or heat demand.

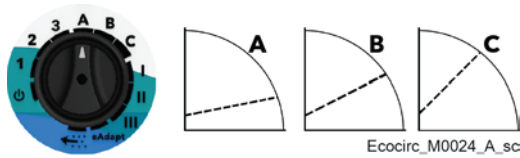

Position	Description
A	Low performance curve
B	Intermediate performance curve
C	High performance curve

### 6.1.4 Operation with constant pump speed

The speed is kept constant irrespective of the system's actual demand for flow. Suited for one-pipe heating systems and domestic hot water systems.

Select the speed according to the features of the system or number of valves that can be opened at the same time.

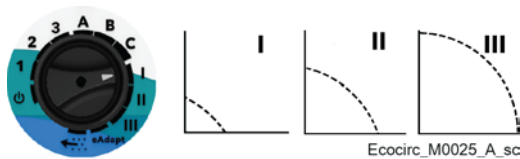

Position	Description
I	Constant pump speed I
II	Constant pump speed II
III	Constant pump speed III

### 6.1.5 eAdapt function, ecocirc+

Optimises energy consumption by constantly identifying the ideal duty point.



Action	LED	Illustration
Turn the knob to eAdapt	Green steady	

### 6.1.6 Degassing function

See Venting the unit on page 20.

## 6.2 Night mode, ecocirc+

Reduces energy consumption of the unit when the heating system is not in operation. A self-learning process identifies the suitable operating conditions; the electronic system registers lowering of the temperature and the unit automatically reduces the speed. The unit returns to the original duty point as soon as the system restarts and the water temperature increases.

Phase	Action	LED	Illustration
1	Select an operating mode from 1, 2, 3, A, B, C, I, II and III	Steady green = night mode OFF	
2	Press the button (briefly) to activate or deactivate night mode	Steady yellow = night mode ON Steady green = night mode OFF	



Note: if night mode is still active when the power is turned off, it will be deactivated the next time the power is turned on again.

## 6.3 MY ecocirc App, ecocirc+

Available for iOS® or Android™ mobile devices with Bluetooth® wireless technology.  
The MY ecocirc can be used to:

- Interact with the unit and obtain data during installation and maintenance
- Access technical information and supporting documentation
- Generate a work report
- Identify the most suitable model for a specific system
- Contact the assistance service.

### 6.3.1 Pairing the unit with a mobile device

Phase	Action	Illustration
1	Open MY ecocirc on a mobile device	
2	Activate Bluetooth® connectivity	
3	Press and hold the button for a while: the LED flashes and the unit is available for pairing	 <p style="text-align: right; font-size: small;">Ecocirc_M0030_A_ph</p>
4	Touch ecocirc+... in the list of units detected by the mobile device	
5	Press the button briefly: the first 3 digits of the PIN appear on the display	 <p style="text-align: right; font-size: small;">Ecocirc_M0032_A_ph</p>
6	Enter the 3 digits in MY ecocirc	



7	Press the button again briefly: another 3 digits of the PIN appear on the display	
8	Enter the 3 digits in MY ecocirc and confirm: pairing is complete	

## 6.4 Starting at high torque

If the motor shaft is locked, for example due to limescale, the unit automatically makes several attempts to start at high torque. During this phase:

- The unit vibrates and makes a noise
- The LED is red and steady
- The error code E04 (ecocirc+) is shown on the display.

When locking is resolved, the unit continues to run normally (green LED).

## 6.5 Dry run signal

Protects the unit against dry running during start-up and normal operation:

- During the first 24 hours, the unit continues to run and the LED is red and flashing
- After 24 hours, the unit stops and the LED is red and steady
- The error code E10 (ecocirc+) is shown on the display.

See Troubleshooting on page 27.

# 7 Maintenance

## 7.1 Precautions

Before starting, make sure that the instructions shown in **Introduction and Safety** on page 5 have been fully read and understood.



---

**WARNING:**

Maintenance must be done by a technician possessing the technical-professional requirements outlined in the current regulations.

---

---



---

**WARNING:**

Always wear personal protective equipment.

---

---



---

**WARNING:**

Always use suitable working tools.

---

---



---

**WARNING:**

In the case of liquids that are excessively hot or cold, pay attention to the risk of injury.

---

---



---

**DANGER: Electrical hazard**

Before starting work, check that the power supply is disconnected and locked out, to avoid unintentional restart of the unit, the electronic drive and the auxiliary control circuit.

---

## 7.2 Spare parts ordering

Identify the spare parts with the product codes directly on the site [www.lowara.com/spark](http://www.lowara.com/spark). Contact Xylem or the Authorised Distributor for technical information.

# 8 Troubleshooting

## 8.1 Precautions



---

**WARNING:**

Maintenance must be done by a technician possessing the technical-professional requirements outlined in the current regulations.

---



---

**WARNING:**

Observe the safety requirements in the chapters on Use and Operation and Maintenance.

---



---

**WARNING:**

If a fault cannot be corrected or is not mentioned, contact Xylem or the Authorised Distributor.

---

### 8.1.1 Resetting errors

Errors may sometimes need resetting:

1. Disconnect the power supply.
2. Wait 1 minute.
3. Turn on the power supply.

## 8.2 Insufficient cooling or heat

LED	Error	Cause	Solution
Green steady	None	Inadequate performance levels by the unit	<ul style="list-style-type: none"> <li>• Increase head by increasing speed and wait for the system to become fully operational, or</li> <li>• Select a different operating mode and wait for the system to become fully operational</li> </ul> If the problem continues, replace the unit
Yellow steady	None	Night mode activated, ecocirc+	Deactivate night mode If the problem continues, replace the unit
Flashing red light	None	Dry running detected	<ol style="list-style-type: none"> <li>1. Check that the system is free of air</li> <li>2. Check that the pumped liquid pressure conforms with the working limits</li> <li>3. Check that the unit is installed according to the instructions in the manual</li> <li>4. Initiate the degassing process</li> </ol> If the problem continues, replace the unit

## 8.3 Unit not functioning and LED on

The unit is not functioning, the LED is on and the display (ecocirc+) is showing an error code.

LED	Error	Cause	Solution
Flashing yellow light	OFF	Knob set to stand-by	Select an operating mode from 1, 2, 3, A, B, C, I, II and III
Red steady	E02	Motor overcurrent	Reset the error; if the problem persists, replace the unit
	E03	Supply voltage too high	1. Check that the grid voltage conforms to the rated values 2. Reset the error If the problem continues, replace the unit
	E03 or E06	Regeneration effect due to water flow generated by other equipment	1. Remove the source of the flow 2. Reset the error If the problem continues, replace the unit
	E04	Motor stalled, rotor blocked or loss of speed	The unit automatically carries out several high-torque startup attempts. If the problem continues: 1. Check that the pumped liquid conforms with the working limits 2. Clean the system 3. Reset the error If the problem continues, replace the unit
	E05	Motor control error	Reset the error; if the problem persists, replace the unit
	E06	Supply voltage too low	1. Check that the grid voltage conforms to the rated values 2. Reset the error If the problem continues, replace the unit
	E07	Motor overload	1. Disconnect the power supply 2. Wait for the unit to cool down 3. Check that the pumped liquid conforms with the working limits 4. Activate the power supply If the problem continues, replace the unit
	E08	Overheating	1. Disconnect the power supply 2. Wait for the unit to cool down 3. Check that the ambient and pumped liquid temperatures conform to the working limits 4. Check that the unit is installed according to the instructions in the manual 5. Activate the power supply If the problem continues, replace the unit
	E09	Electrical motor failure	Reset the error; if the problem persists, replace the unit
	E10	Protection against dry running	Reset the error; if the problem persists, replace the unit

## 8.4 Unit not functioning and LED off

The unit is not functioning and the LED and the display (ecocirc+) are switched off.



LED	Error	Cause	Solution
Off	None	Tripping of electric safety devices (system fuse, thermal magnetic circuit breaker, earth leakage circuit breaker)	Restore the electric safety devices; replace the fuse for the system and rearm the safety switch
		Power supply disconnected	Activate the power supply after verifying that the connector is connected to the circulator correctly
		Incorrect wiring	Restore the connector's electrical connections
		Unit faulty	Replace the unit

## 8.5 Loss of functionality in the unit

LED	Error	Cause	Solution
Green steady	A11, or off	Communication failure of the electronic board	Reset the error; if the problem persists, replace the unit

## 8.6 The wireless connection is not functioning, ecocirc+

The unit is operating but it is not possible to establish a Bluetooth® connection with the app.

LED	Bluetooth LED	Error	Cause	Solution
Green steady	Off	None	Button  failure	<ol style="list-style-type: none"> <li>Reset the error</li> <li>Press and hold the button  for more than 4 seconds</li> </ol> If the problem continues, replace the unit
Flashing green light		Air		
Flashing yellow light		OFF		
Red steady		Exx		
Flashing red light		None		
-	Fast flashing	-	Pairing incomplete with the mobile device	Complete the process within 3 minutes
-		-	Incorrect pairing PIN with the mobile device	<ol style="list-style-type: none"> <li>Generate a new PIN and retry pairing</li> <li>Reset the error</li> </ol> If the problem continues, replace the unit
-		Steady light	-	Communication error

## 8.7 Noise coming from the system

LED	Error	Cause	Solution
Green flashing	Air	Degassing active	Select an operating mode from 1, 2, 3, A, B, C, I, II and III and wait for the degassing process to complete (approximately 3 minutes)
Green steady	None	Air in the system	<ul style="list-style-type: none"> <li>Vent the system and initiate the degassing process</li> <li>Wait for the degassing process to complete (approximately 3 minutes)</li> </ul>
		Flow rate too high, turbulence	<ul style="list-style-type: none"> <li>Select a different operating mode, or</li> <li>Decrease head by reducing speed</li> </ul>
		System features (piping sections, curve shapes, presence of valves)	Inspect the system

## 8.8 Noise coming from the unit

LED	Error	Cause	Solution
Green flashing	Alr	Degassing active	Select an operating mode from 1, 2, 3, A, B, C, I, II and III and wait for degassing to complete (approximately 3 minutes)
Green steady	None	Air in the unit	<ul style="list-style-type: none"> <li>• Check that the unit has not been installed at the highest point of the system, and/or</li> <li>• Initiate the degassing process and wait for it to complete (approximately 3 minutes)</li> </ul>
		Cavitation	<ul style="list-style-type: none"> <li>• Increase system pressure within the working limits, or</li> <li>• Select a different operating mode, or</li> <li>• Decrease head by reducing speed</li> </ul> If the problem continues, replace the unit
		Foreign bodies in the unit	Clean the system; if the problem persists, replace the unit

# 9 Technical Information

## 9.1 Operating environment

Non-aggressive, non-explosive atmosphere, and not subjected to frost.

### Temperature

-10 to 40°C (-14 to 104°F).

### Relative air humidity

< 95% at 40°C (104°F).

---

#### NOTICE:

If the temperature and humidity exceed the stated limits, contact Xylem or the Authorised Distributor.

---

#### NOTICE:

To avoid the formation of condensate in the electronic drive and stator, the temperature of the liquid must be kept above room temperature.

---

## 9.2 Pumped liquid

### Temperature

-10 to 110°C (14 to 230°F).

### Water hardness

0 to 21°f (0 to 14°d).

### Concentration of water/glycol mixture

≤ 50%.

## 9.3 Mechanical characteristics

### Protection degree

IP 44.

### Class of the device

I.

### Minimum suction pressure @ head @ temperature of the liquid

Pressure, MPa (psi)	Head, m (ft)	Temperature, °C (°F)
0.005 (0.725)	0.5 (1.6)	50 (122)
0.03 (4.35)	3 (10)	95 (203)
0.1 (14.5)	10 (33)	110 (230)

### Temperature class

TF110, according to EN 60335-2-51.

## 9.4 Electrical specifications

### Power Supply Voltage

1 x 230 V ± 10%, 50/60 Hz, PE.

### Insulation class

155 (F).

## 9.5 Radiofrequency specifications, ecocirc+

Bluetooth® 5.0 LE wireless technology  
 2.4 GHz ISM Band  
 RF ≤ 2.5 mW (+ 4 dBm)

## 9.6 Maximum head

### ecocirc

Model	Head, m (ft)	Model	Head, m (ft)	Model	Head, m (ft)
S 15-4/130 (N)	4 (13)	M 20-6/150 (N)	6 (20)	L 25-8/180 (N)	8 (26)
M 15-6/130 (N)	6 (20)	S 25-4/130 (N)	4 (13)	S 32-4/180 (N)	4 (13)
L 15-8/130 (N)	8 (26)	S 25-4/180 (N)	4 (13)	M 32-6/180 (N)	6 (20)
S 20-4/130	4 (13)	M 25-6/130 (N)	6 (20)	L 32-8/180 (N)	8 (26)
S 20-4/150 (N)	4 (13)	M 25-6/180 (N)	6 (20)	-	-
M 20-6/130	6 (20)	L 25-8/130 (N)	8 (26)	-	-

### ecocirc+

Model	Head, m (ft)	Model	Head, m (ft)	Model	Head, m (ft)
S+ 15-4/130	4 (13)	S+ 25-4/130	4 (13)	L+ 25-8/180	8 (26)
M+ 15-6/130	6 (20)	M+ 25-6/130	6 (20)	S+ 32-4/180	4 (13)
L+ 15-8/130	8 (26)	L+ 25-8/130	8 (26)	M+ 32-6/180	6 (20)
S+ 20-4/130	4 (13)	S+ 25-4/180	4 (13)	L+ 32-8/180	8 (26)
M+ 20-6/130	6 (20)	M+ 25-6/180	6 (20)	-	-

## 9.7 Maximum operating pressure

1 MPa (145 psi).

## 9.8 Energy efficiency

Model	EEl
ecocirc / + XX_4/XX	≤ 0.15
ecocirc / + XX_6/XX	≤ 0.17
ecocirc / + XX_8/XX	≤ 0.18

## 9.9 Sound pressure

LpA, measured in free field at a distance of one meter from the unit:  
 ≤ 43 dB ± 2.



## 9.10 Materials in contact with the liquid

Item	Material
Rotor cage	AISI 316 stainless steel
Sleeve, wear ring	AISI 304 stainless steel
Pump body	AISI 304 stainless steel / EN-GJL-200 cast iron
Impeller insert	CW510L brass
Shaft, bush	Aluminum oxide
Thrust support, O-ring	EPDM
Thrust bearing	Graphite
Rotor	PPS composite
Impeller	PPE/PS-I composite

## 9.11 Dimensions and weights

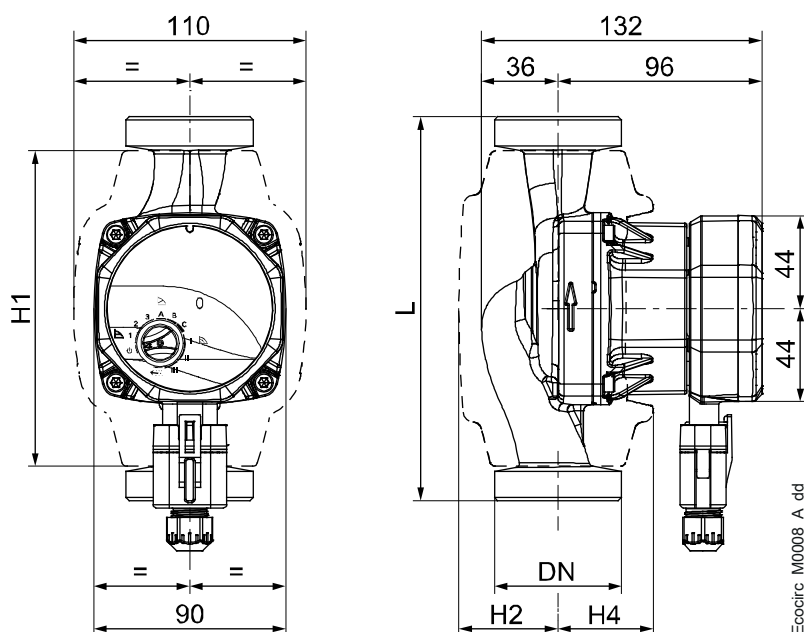

Model	L, mm	DN	H1, mm	H2, mm	H4, mm
15-4/130	130	G1 / R ½	142	46	44
20-4/130	130	G 1 ¼ / R ¾	142	46	44
25-4/130	130	G1 ½ / R 1	142	46	44
25-4/180	180	G1 ½ / R 1	148	47	45
32-4/180	180	G2 / R 1 ¼	148	47	45
15-6/130	130	G1 / R ½	142	46	44
20-6/130	130	G 1 ¼ / R ¾	142	46	44
25-6/130	130	G1 ½ / R 1	142	46	44
25-6/180	180	G1 ½ / R 1	148	47	45
32-6/180	180	G2 / R 1 ¼	148	47	45
15-8/130	130	G1 / R ½	142	46	44
15-8/130	130	G1 ½ / R 1	142	46	44
15-8/180	180	G1 ½ / R 1	148	47	45
15-8/180	180	G2 / R 1 ¼	148	47	45

# 10 Disposal

## 10.1 Precautions



---

**WARNING:**

The unit must be disposed of through approved companies specialised in the identification of different types of materials (steel, copper, plastic, etc.).

---

---



---

**WARNING:**

It is prohibited to dispose of lubricating fluids and other hazardous substances in the environment.

---

## 10.2 WEEE 2012/19/EU (50 Hz)

(IE) (MT) (GB) - INFORMATION TO USERS pursuant to art. 14 of the Directive 2012/19/EU of the European Parliament and of the Council of 4 July 2012 on waste electrical and electronic equipment (WEEE).



The crossed bin symbol on the appliance or on its packaging indicates that the product at the end of its useful life must be collected separately and not disposed of together with other mixed urban waste. Appropriate separate collection for the subsequent start-up of the disused equipment for recycling, treatment and environmentally compatible disposal helps to avoid possible negative effects on the environment and on health and favors the re-use and / or recycling of the materials it is composed of the equipment.

WEEE other than WEEE from private households<sup>1</sup>: The separate collection of this equipment at the end of its life is organized and managed by the producer. The user who wants to get rid of this equipment can then contact the producer and follow the system that it has adopted to allow the separate collection of equipment at the end of life, or select a supply chain independently authorized to manage.

Producer of EEE as per Directive 2012/19/EU:

(IE)

Xylem Water Solutions Ireland Ltd - 50 Broomhill Close - Airton Road - D24 Tallaght - Dublin 24

(MT)

-

(GB)

Xylem Water Solutions UK Ltd - Millwey Rise Industrial Estate - Axminster - Devon EX13 5HU

---

<sup>1</sup> Classification according to product type, use and current local laws

# 11 Declarations

## 11.1 EC Declaration of Conformity (Original)

Xylem Service Italia S.r.l., with headquarters at Via Vittorio Lombardi 14 - 36075 Montecchio Maggiore VI - Italy, hereby declares that the product:

Circulator ecocirc S, .. M, ..L, ..S+, ..M+, .. L+ (see rating plate)

fulfils the relevant provisions of the following European Directives:

- 2006/42/EC Machinery and subsequent amendments (ATTACHMENT II - physical or legal person authorised to compiling the technical folder: Xylem Service Italia S.r.l.)
- Eco-design 2009/125/EC and subsequent amendments, Regulations (EC) no. 641/2009 and (EU) no. 622/2012:  $EEL \leq 0$ , ... see label on the manual and product (Annex I: "The parameter of reference for the most efficient circulators is  $EEL \leq 0.20$ .")

and the following technical standards:

- EN 60335-1:2012+A11:2014+A13:2017, EN 60335-2-51: 2003+A1:2008+A2:2012, EN 62233:2008
- EN 16297-1:2012, EN 16297-2:2012

Montecchio Maggiore, 23/05/2019

Amedeo Valente  
(Director of Engineering and R&D)



rev.00

## 11.2 EU Declaration of Conformity (n. 39)

1. (EMCD) Apparatus/Product model: ecocirc S, .. M, ..L (see rating plate)  
(RED) Radio equipment: ecocirc S+, ..M+, .. L+ (see rating plate)  
(RoHS) Unique identification of the EEE: N. ecocirc S, .. M, .. L, .. S+, .. M+, .. L+
2. Name and address of the manufacturer:  
Xylem Service Italia S.r.l.  
Via Vittorio Lombardi 14  
36075 Montecchio Maggiore VI  
Italy
3. This declaration of conformity is issued under the sole responsibility of the manufacturer.
4. Object of the declaration:  
Circulator
5. The object of the declaration described above is in conformity with the relevant Union harmonization legislation:
  - ecocirc S, .. M, ..L: 2014/30/EU Directive of 26 February 2014 (electromagnetic compatibility) and subsequent amendments
  - ecocirc S+, .. M+, ..L+: 2014/53/EU Directive of 16 April 2014 (radio equipment) and subsequent amendments
  - ecocirc S, .. M, .. L, .. S+, .. M+, .. L+: 2011/65/EU Directive of 8 June 2011 (restriction of the use of certain hazardous substances in electrical and electronic equipment) and subsequent amendments
6. References to the relevant harmonized standards used or references to the other technical specifications, in relation to which conformity is declared:
  - EN 55014-1:2006+A1:2009+A2:2011, EN 55014-2:1997+A1:2001+A2:2008, EN 61000-3-2:2014, EN 61000-3-3:2013, EN 61000-6-3:2007+A1:2011
  - ETSI EN 301 489-1 v.2.1.1 (2017-02), ETSI EN 301 489-17 V2.2.1 (2012-09), ETSI EN 300 328 v.2.1.1. (2016-11) and those of the previous point
  - EN 50581:2012
7. Notified body: -
8. Any accessories/components/software: -

9. Additional information:

RoHS - Annex III - Applications exempt from the restrictions: lead as a binding element in steel, aluminium, copper alloys [6a), 6b), 6c)], in welds and electric/electronic components [7a), 7c)-I, 7c)-II]

ecocirc	6(a)	6(b)	6(c)	7(a)	7(c)-I	7(c)-II
S, M, L	•	•	•	-	-	-
S+, M+, L+	•	•	•	•	•	•

Signed for and on behalf of: Xylem Service Italia S.r.l.

Montecchio Maggiore, 23/05/2018

Amedeo Valente  
(Director of Engineering and R&D)



rev.00

Lowara is a trademark of Xylem Inc. or one of its subsidiaries.

# 12Warranty

## 12.1 Information

For information on the warranty refer to the documentation of the sale contract.

# Xylem |'zīləm|

- 1) The tissue in plants that brings water upward from the roots;
- 2) A leading global water technology company.

We're a global team unified in a common purpose: creating innovative solutions to meet our world's water needs. Developing new technologies that will improve the way water is used, conserved, and re-used in the future is central to our work. We move, treat, analyze, and return water to the environment, and we help people use water efficiently, in their homes, buildings, factories and farms. In more than 150 countries, we have strong, long-standing relationships with customers who know us for our powerful combination of leading product brands and applications expertise, backed by a legacy of innovation.

For more information on how Xylem can help you, go to [www.xylem.com](http://www.xylem.com)



Xylem Service Italia S.r.l.  
Via Vittorio Lombardi 14  
36075 - Montecchio Maggiore (VI) - Italy  
[www.xylem.com/brands/lowara](http://www.xylem.com/brands/lowara)

IOS® is a registered trademark of Cisco Systems, Inc. and/or its affiliates in the United States and certain other countries.  
Android is a trademark of Google LLC.  
The Bluetooth® word mark and logos are registered trademarks owned by Bluetooth SIG, Inc. and any use of such marks by Xylem Service Italia S.r.l is under license.  
Lowara is a trademark of Xylem Inc. or one of its subsidiaries.  
© 2020 Xylem, Inc. Cod.001084060EN rev.A ed.02/2020